

# EL<sup>®</sup>MARK

The Brand of Electricity

## BELLA LUMINAIRE SMD



### GENERAL INFORMATION »

- ∴ Rated voltage: 230V/ 50-60Hz
- ∴ Power: 20W; 40W; 55W
- ∴ Colour temperature: 4000-4300K; 6300-6500K
- ∴ LED source: Epistar
- ∴ LED type: SMD2835
- ∴ Body: polycarbonate (PC), grey
- ∴ Diffuser: polycarbonate (PC), Opal cover
- ∴ Reflector: Steel white
- ∴ Colour rendering index: Ra≥80
- ∴ Switch on/off: 20 000
- ∴ Average life: 30 000h
- ∴ Protection against mechanical impacts: IK08
- ∴ Protection against dust and moisture: IP65
- ∴ Available in variant with an emergency kit



## FEATURES »

- ∴ Replacement of conventional fluorescent tubes with highly efficient LED strip
- ∴ Installation options: surface ceiling mounting
- ∴ Low power consumption
- ∴ Repeated switch-on/off does not affect the lifespan of the luminaire
- ∴ Instant light with maximum luminous flux
- ∴ No ultraviolet and infrared rays
- ∴ Stable and functional light distribution

## AREAS OF APPLICATION »

- ∴ Damp areas
- ∴ Dusty environment
- ∴ Kitchen premises
- ∴ Roofed outdoor areas

## PRODUCT DETAILS »

Catalogue number	Catalogue number with Emergency kit	Watt (W)	Whole fixture lumens (lm)	Colour temp. (K)	Colour body
9BR20LED	-	20	1800	4000	grey
9BR20LEDCW	-	20	1800	6500	grey
9BR40LED	9BR40LEDE	40	3800	4000	grey
9BR40LEDCW	9BR40LEDCWE	40	43800	6500	grey
9BR55LED	9BR55LEDE	55	5000	4000	grey
9BR55LEDCW	9BR55LEDCWE	55	5000	6500	grey

## DIMENSIONS »

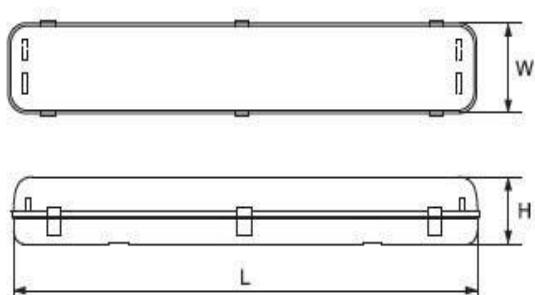

Model	Length	Width	Height
9BR20LED	600	80	70
9BR20LEDCW	600	80	70
9BR40LED	1200	80	70
9BR40LEDCW	1200	80	70
9BR55LED	1476	80	70
9BR55LEDCW	1476	80	70

## LED EMERGENCY KIT SPECIFICATIONS »



### General information »

- ∴ Voltage: AC85-265V 50Hz
- ∴ Emergency Output: 3-40W
- ∴ Emergency Time: > 2hrs (120mins)
- ∴ Battery: 3.7V 2400mAh
- ∴ Emergency Switching Time: <2s
- ∴ AC Fuse: 250V 1A
- ∴ DC Fuse: 250V 5A
- ∴ Luminous Flux: >100lm
- ∴ Light Source: LED
- ∴ Working temperature: -10°C +55°C
- ∴ IP Rate: IP30

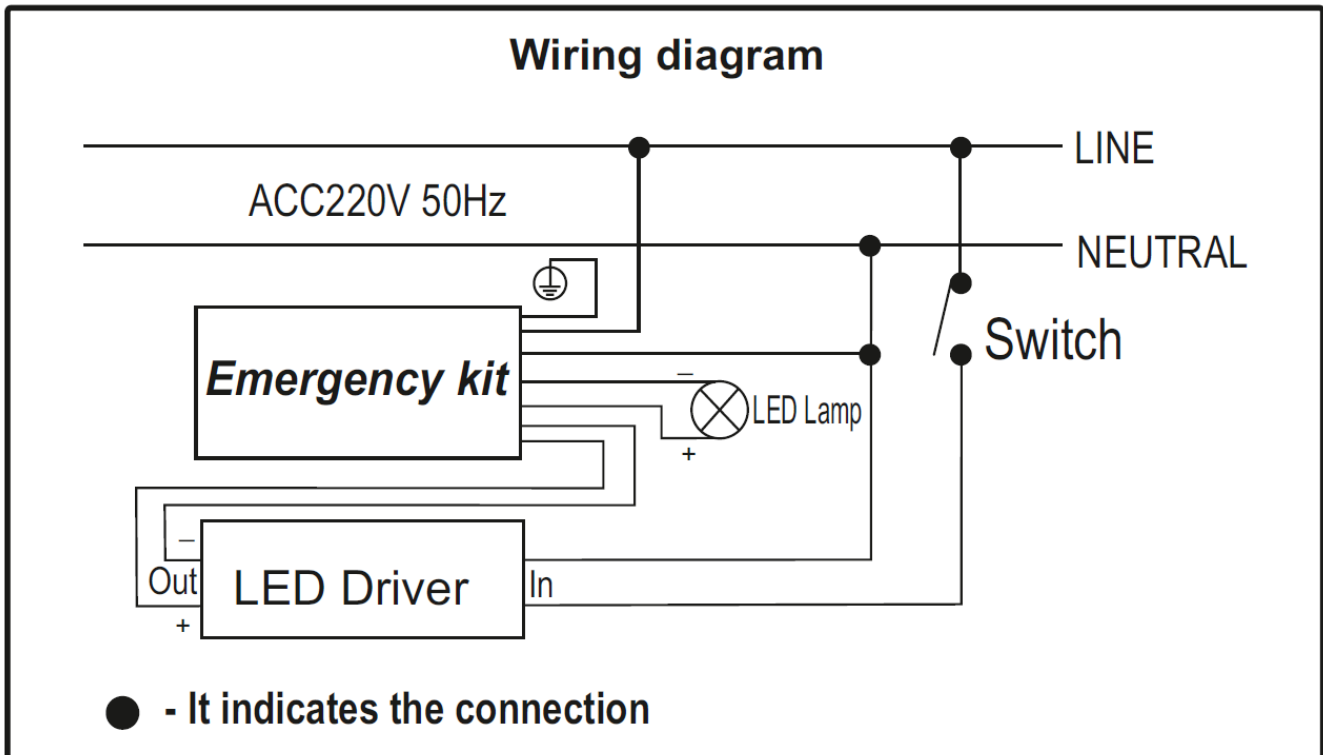
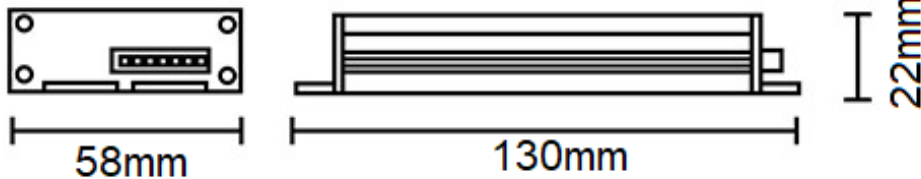

● Red = Charging ● Blue = Emergency ● Green = Power

ADDITIONAL INFORMATION »

9BR20LED



This luminaire contains built-in LED lamps.



L  
E  
D

The lamps cannot be changed in the luminaire.

874/2012

Catalogue number	Barcode	Packing/Box (pcs)
9BR20LED	3800131192417	1/16
9BR20LEDCW	3800131217950	1/16
9BR40LED	3800131192424	1/12
9BR40LEDCW	3800131210630	1/12
9BR55LED	3800131192431	1/9
9BR55LEDCW	3800131210647	1/9

